

Magnetic Holding CZW252A-K Magnetic Holding DC Contactor

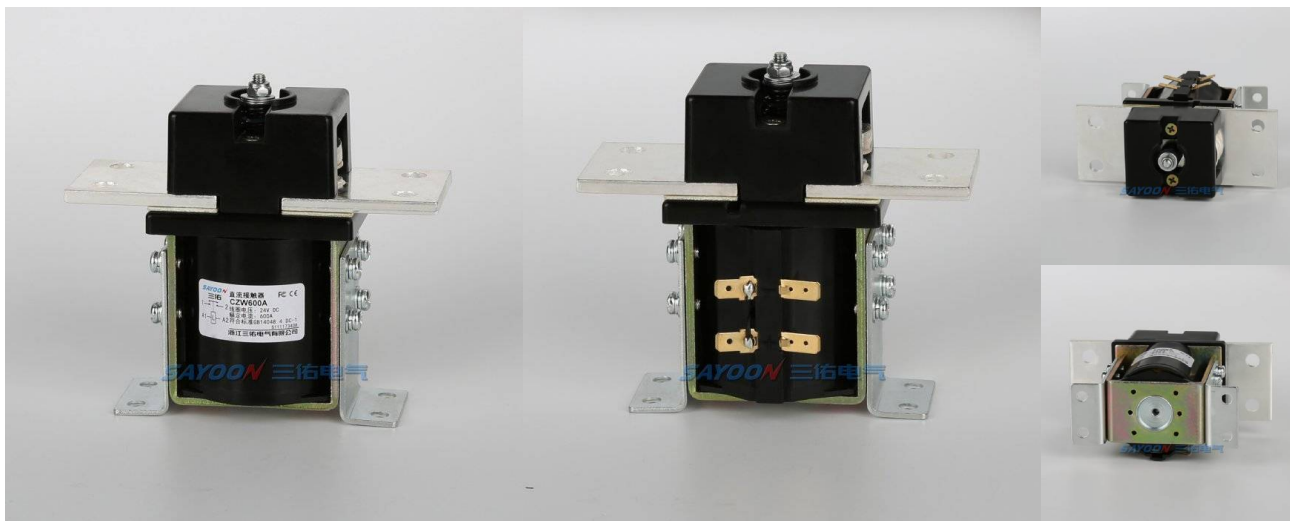

USES

This product realizes zero power connection when working. It is suitable for 5G、charging pile, telecommunication communication equipment, automation equipment, electric vehicle, energy-saving and environmental protection system, road traffic lighting system, programmable power supply and uninterrupted power supply equipment.

<u>CZW</u>	<u>252A</u>	<u>-K</u>	<u>-S</u>	<u>-□</u>	<u>-□</u>	<u>/24V</u>
1	2	3	4	5	6	7
1	Product type					
2	Rated current:250A					
3	Magnetic holding structure: K Two joint magnetic retention(Single coil, Two joint self-locking); 2K Three joint magnetic retention(Double coil, Three joint self-locking)					
4	Auxiliary switch: None - Without auxiliary switch; S - With auxiliary switch					
5	Mounting bracket type: 2L Two vertical (default), M Horizontal , 1L One vertical, X Oblique, 1LW One vertical horizontal, 2N Rear					
6	Other function codes: I: With suppressor diode, R: With pre-charged resistance					
7	Coil rated voltage: 6V,12V,24V,36V,48V,60V,72V,84V,120V,150V,220V etc.					

ORDER FORM DESCRIPTION

When ordering, please state the following: name, full model, control coil voltage specification, installation frame type, whether with auxiliary contact, order quantity. For example: Magnetic Holding DC Contactor CZW252A-K/24V 100pcs, indicating the load rated current 250A, without auxiliary contact, default mounting bracket, coil control voltage 24V purchase 100pcs. Special voltage specification products, such as user needs can be special order.

TECHNICAL PARAMETERS

(Version 1.63)

SAYOON Product Type	CZW252A-K
Contact form	1 Circuit
Coil Rated voltage (DC V)	6V,12V,24V,36V,48V,60V,72V,84V,120V,150V,220V etc.
Contact voltage (DC V)	≤80V
Rated load current of contact 48V circuit (DC-1)	250A
Typical voltage drop across contacts per 100A	≧80mV
The cooling pull-in voltage at (20±5)°C (V)	≧80%
The cooling drop-out voltage at (20±5)°C (V)	≧80%
Working voltage range of 40°C coil	0.8-1.2Us
Pulse dration	200ms≤t≤1s
Operating frequency(square wave)	1 minute≤6 times
Insulation Resistance	100MΩ
Electric strength to resist	50Hz/60Hz 2200VAC 1minute
Typical fault currents which can be ruptured	1500A/5ms at 48V DC
Coil power (W)	K Start: 15-30, Keep: 0
Temperature rise of coil (K)	Normal temperature
Temperature rise on outgoing terminal (K)	≤65
Electrical life	10,000 times
Mechanical life	300,000 times
Work specification	Continuous
Contact material	Ag alloy
Load terminal type	2-M6 Screw

LOAD CHARACTERISTIC CURVE



OTHER TECHNICAL PARAMETERS

Coil terminal type	6.3mm spade terminals
Auxiliary contact rated load (optional)	2A/48VDC, 5A/24VDC

Note:As regarding to the different using environments of customers which requires different focus of the functions,and in order to improve the comprehensive properties of our products,sayoon may adjust the coil parameters,temperature rise and so on. The above parameters are for reference only, For details, please refer to the guidelines for selection and use of the SAYOON DC contactor.

INSTALLATION DIAGRAM

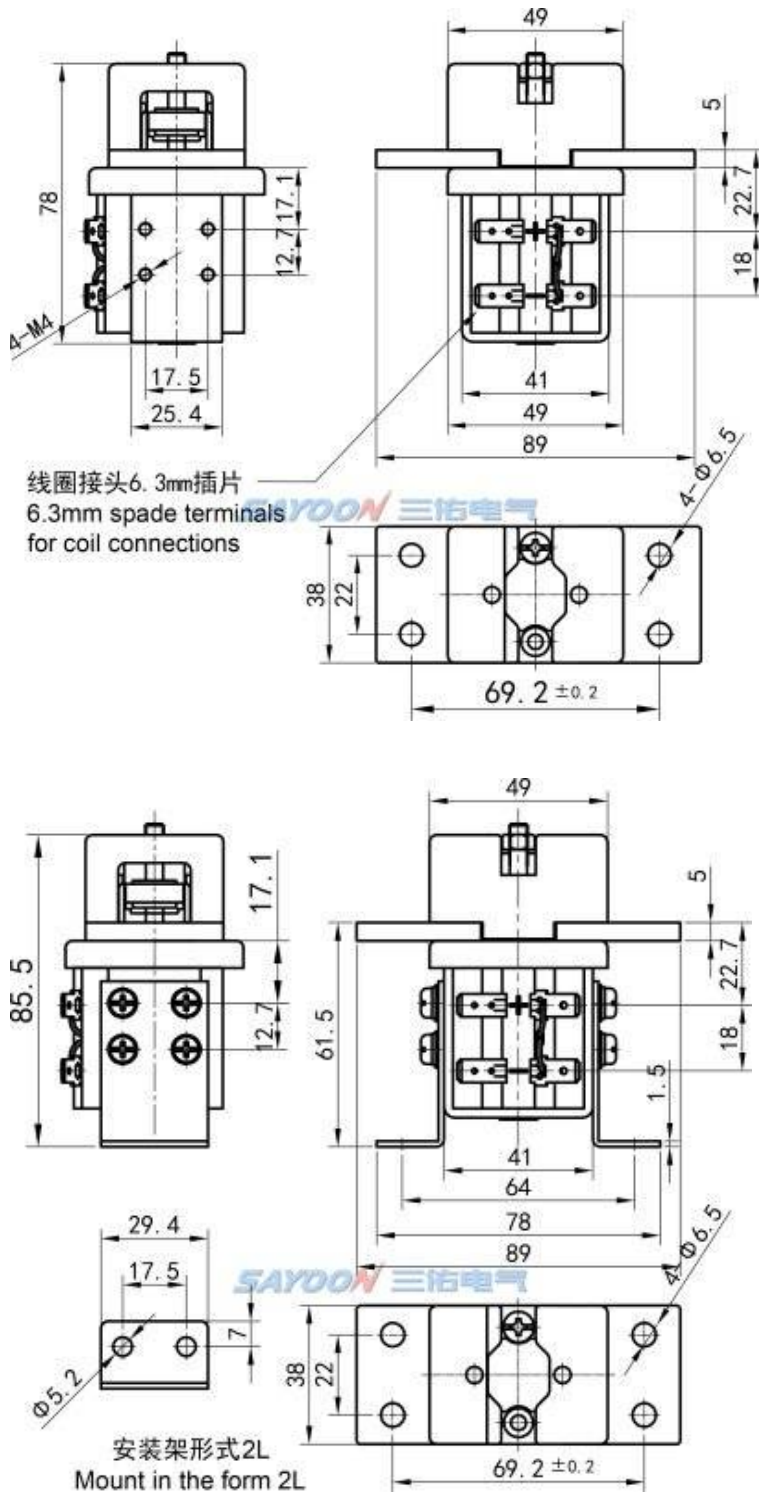

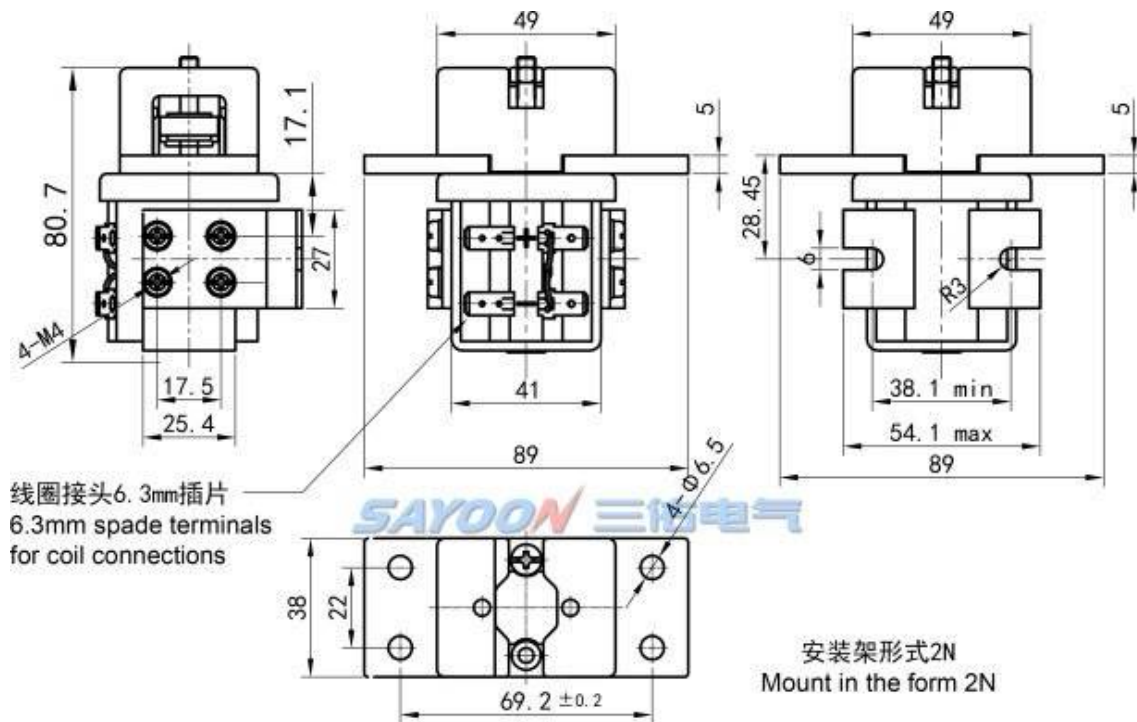
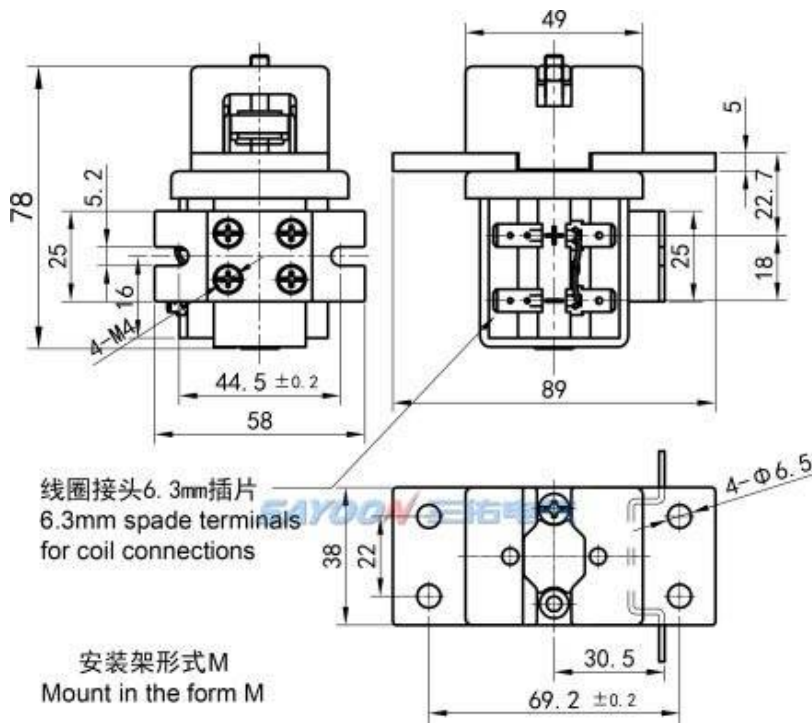

WIRING DIAGRAM

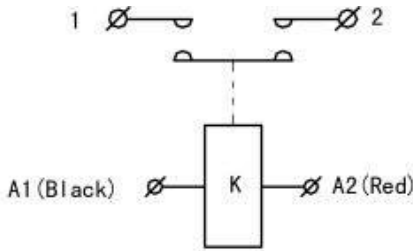

K Two Jiont Magnetic Retention(Two Jiont Self-locking)

1.2 Main Contact Terminal

A1(Black).A2(Red) Coil Terminal

A1(Black) Connect the negative pole of the power supply
A2(Red) Connect the positive pole of the power supply
1. 2 Main contact on.
A1(Black) Connect the positive pole of the power supply
A2(Red) Connect the negative pole of the power supply
1. 2 Main contact disconnection.

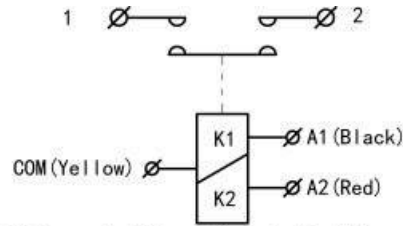

2K Three Jiont Magnetic Retention(Three Jiont Self-locking)

1.2 Main Contact Terminal

A1(Black).COM(Yellow).A2(Red) Coil Terminal

Common positive electrode:COM(Yellow)Connect the positive pole of the power supply
A1(Black)Connect the negative pole of the power supply , 1. 2 Main contact on.
COM(Yellow)Connect the positive pole of the power supply
A2(Red)Connect the negative pole of the power supply , 1. 2 Main contact disconnection.
Public negative electrode:COM(Yellow)Connect the negative pole of the power supply
A1(Black)Connect the positive pole of the power supply , 1. 2 Main contact disconnection.
COM(Yellow)Connect the negative pole of the power supply
A2(Red)Connect the positive pole of the power supply , 1. 2 Main contact on.

FEATURES

Suitable for electric forklift, battery cars, tractors, excavators, brick machine, cleaning vehicles, automotive air-conditioning, communication power supply, uninterruptible power supply, power supply switches such as electroplating electronic control system control circuit, has the advantages of small volume, large load capacity, long service life, easy maintenance and other characteristics, welcomed by users. The products in accordance with the standard of the JB2286-78, JB3974-85, YD / 585-92, YD / T512-92 requirements; the plant and related test unit test, meet the standard requirements, the user use for many years, the maximum to meet user needs, quality and reliable.